

CONTROL PANEL

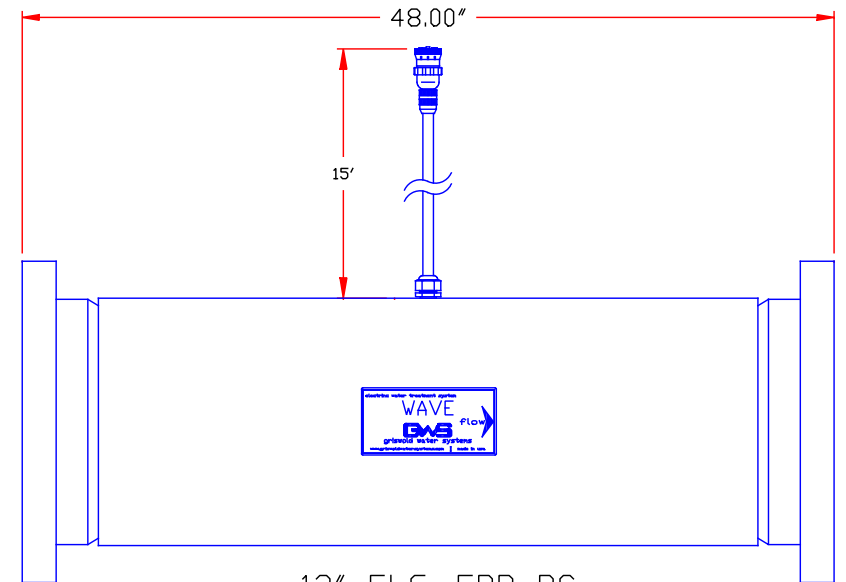

12" FLG. FRP RC  
ELEVATION  
SCH 40 PVC SHELL

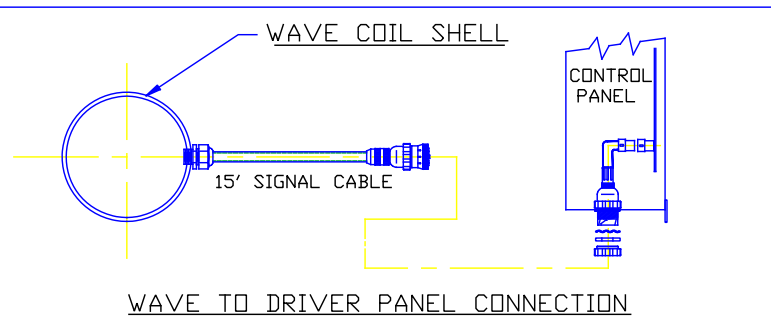

WAVE TO DRIVER PANEL CONNECTION

THIS DOCUMENT MAY CONTAIN PROPRIETARY INFORMATION. IT MAY NOT BE REPRODUCED OR TRANSFERRED TO OTHERS OR USED FOR MANUFACTURING OR ANY OTHER PURPOSE WITHOUT PRIOR WRITTEN PERMISSION.

**GRISWOLD WATER SYSTEMS**  
1597 INDUSTRIAL DRIVE, NEW SMYRNA BEACH, FL 32168

**WAVE 12 INCH**

DRAWN	-	DATE	-	MATERIAL:	FRP/PVC	DRAWING NO.	WAVE 1200-FF	SIZE	B	REV.	A
APPROD	-		-	WEIGHT:		SCALE	N/A				SHEET 1 OF 1

This drawing is for spatial consideration only. Do not pre-plumb to these dimensions.